

PART NUMBER: LED-6060-07

DESCRIPTION: 10X10X9.7mm 6X6 LED TACT SWITCH WITH KNOB

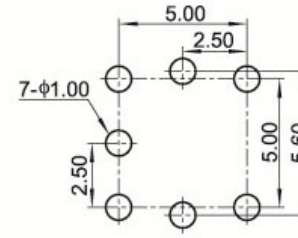
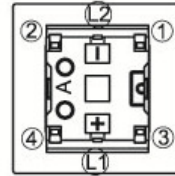
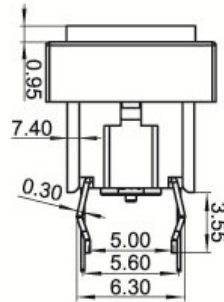
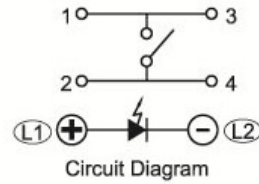
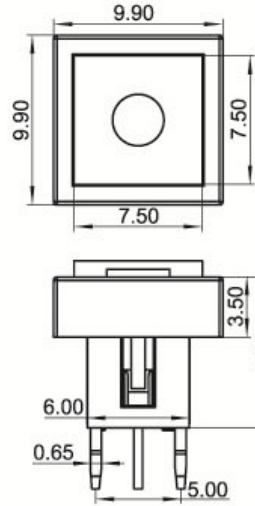
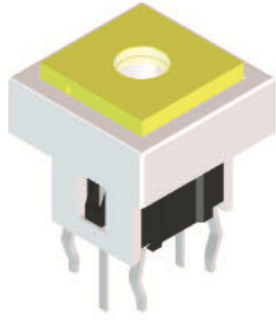

PCB Layout Recommended

Color	VR	IF	Recommended Operating	IF	
				Nom	Max
White	DC5V	20mA	20mA	3.0V	3.6V
Red	DC5V	20mA	20mA	1.7V	2.4V
Yellow	DC5V	20mA	20mA	1.9V	2.4V
Blue	DC5V	20mA	20mA	3.0V	3.6V
Green	DC5V	20mA	20mA	1.9V	2.4V

ROHS COMPLIANT

ILLUMINATED LED SWITCH

SPECIFICATIONS

Items		Standard
Operating temperature range		-25°C to +85°C
Electrical performance	Rating	50mA. 30V DC
	Insulation resistance	100MΩ min. 100V DC
	Dielectric strength	250V AC for 1 min.
	Contact resistance	100mΩ max.
Durability	Lifetime	100,000 Cycles
Mechanical performance	Operating force	160gf 250gf
	Travel	0.25 ± 0.1mm

PART NUMBER: LED-6060-08

DESCRIPTION: 10 dia. x 9.4mm 6X6 LED TACT SWITCH WITH KNOB

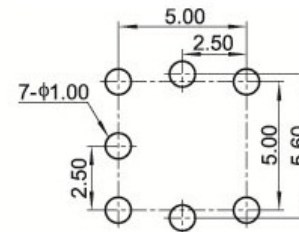
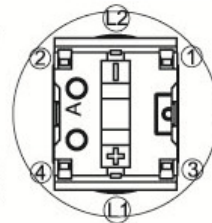
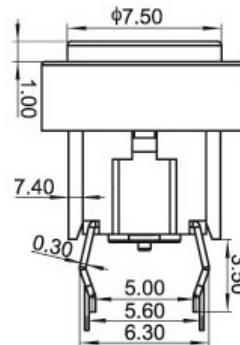
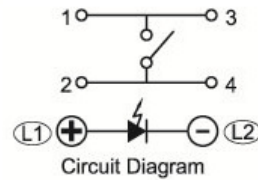
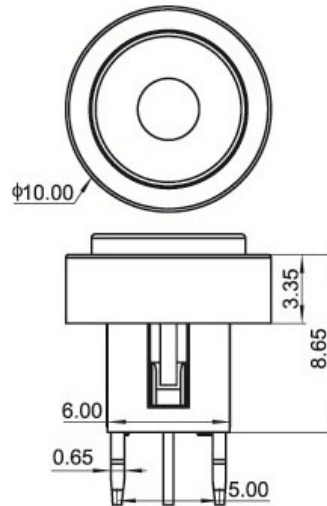

PCB Layout Recommended

Dimensional tolerance +/- 0.2mm

PRAN ELECTRONICS PVT. LTD.
INDIA.